







Suction cups with connection attachments ESS/suction cups ESV



Suction cups with connection attachments ESS/suction cups ESV



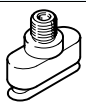



Product range overview

Suction cup shape	Suction cup design	Suction cup Ø or suction cup size [mm]	Vacuum port	Classification of suction cup holders → ESH	Materials						→ Page/ Internet		
					Fluoro elastomer	Nitrile rubber	Butadiene rubber, anti-static	Silicone ¹⁾	Polyurethane	Vulkollan®			
Round	Flat												
		ESS-...-S...	2, 4	O.D. 3 mm ²⁾	Size 1	■	■	■	■	■	-	5	
			6, 8	I.D. 4 mm ²⁾	Size 2	■	■	■	■	■	-		
			10, 15	M4	Size 3	■	■	■	■	■	-		
			20, 30, 40, 50	M6	Size 4	■	■	■	■	■	-		
			60, 80, 100	M10	Size 5	■	■	-	■	■	-		
			150, 200	M20x2	Size 6	■	■	-	■	■	-		
	Extra deep												
		ESS-...-E...	15	M4	Size 3	■	■	-	■	■	-	10	
			20, 30, 40, 50	M6	Size 4	■	■	-	■	■	-		
			60, 80, 100	M10	Size 5	■	■	-	■	■	-		
	Bellows with 1.5 convolutions												
		ESS-...-B...	10	M4	Size 3	-	■	-	■	■	-	13	
			20, 30, 40, 50	M6	Size 4	-	■	-	■	■	-		
			80	M10	Size 5	-	■	-	■	■	-		
		ESS-...-BT	40, 50	M6	Size 4	-	-	-	-	-	■	16	
				M10	Size 5	-	-	-	-	-	■		
			80	M10	Size 5	-	-	-	-	-	-		■
				G¼	-	-	-	-	-	-	-		■
	Bellows with 3.5 convolutions												
		ESS-...-C...	10	M4	Size 3	-	■	-	■	-	-	19	
			20, 30, 40, 50	M6	Size 4	-	■	-	■	-	-		
	Deep												
		ESS-...-GT	30	M6	Size 4	-	-	-	-	-	■	22	
				M10	Size 5	-	-	-	-	-	■		
				G½	-	-	-	-	-	-	■		
			40, 50	M6	Size 4	-	-	-	-	-	■		
				M10	Size 5	-	-	-	-	-	■		
G¼				-	-	-	-	-	-	■			
60, 80, 100			M10	Size 5	-	-	-	-	-	■			
	G¼	-	-	-	-	-	-	■					
Oval	Flat												
		ESS-...-ON	4x10, 4x20, 6x10, 6x20, 8x20, 8x30, 10x30	M6	Size 4	-	■	-	-	-	-	25	
			15x45, 20x60, 25x75, 30x90	M10	Size 5	-	■	-	-	-	-		

1) Suitable for use in the food industry as per the manufacturer's declaration
 2) Is plugged onto or into the suction cup holder

Suction cups with connection attachments ESS/suction cups ESV

Product range overview

Suction cup shape	Suction cup design	Suction cup Ø [mm]	Materials						→ Page/ Internet	
			Fluoro elastomer	Nitrile rubber	Butadiene rubber, anti-static	Silicone ¹⁾	Polyurethane	Vulkollan®		
Round	Flat									
		ESV-...-S...	20, 30, 40, 50	■	■	■	■	■	-	5
			60, 80, 100, 150, 200	■	■	-	■	■	-	
	Extra deep									
		ESV-...-E...	20, 30, 40, 50, 60, 80, 100	■	■	-	■	■	-	10
	Bellows with 1.5 convolutions									
		ESV-...-B...	20, 30, 40, 50, 80	-	■	-	■	■	-	13
		ESV-...-BT	40, 50, 80	-	-	-	-	-	■	16
	Bellows with 3.5 convolutions									
		ESV-...-C...	20, 30, 40, 50	-	■	-	■	-	-	19
Deep										
	ESV-...-GT	30, 40, 50, 60, 80, 100	-	-	-	-	-	■	22	

1) Suitable for use in the food industry as per the manufacturer's declaration

Suction cups with connection attachments ESS/suction cups ESV

Type codes

ESS - 10 - S N

Type	
ESS	Suction cup with connection attachments
ESV	Suction cup

Suction cup Ø or suction cup size [mm]	
2...200	Round
4x10	Oval
4x20	Oval
6x10	Oval
6x20	Oval
8x20	Oval
8x30	Oval
10x30	Oval
15x45	Oval
20x60	Oval
25x75	Oval
30x90	Oval

Suction cup shape	
S	Round, flat
E	Round, extra deep
B	Round, bellows with 1.5 convolutions
C	Round, bellows with 3.5 convolutions
G	Round, deep
O	Oval, flat

Materials	
F	Fluoro elastomer
N	Nitrile rubber
NA	Butadiene rubber, anti-static
S	Silicone
U	Polyurethane
T	Vulkollan®

Port sizes	
M6	M6 thread
M10	M10 thread
G ¹ / ₈	G ¹ / ₈ thread
G ¹ / ₄	G ¹ / ₄ thread
G ¹ / ₈ -I	G ¹ / ₈ female thread
G ¹ / ₄ -I	G ¹ / ₄ female thread

 - Note
Possible combinations can be found in the ordering data.

Suction cups with connection attachments ESS/suction cups ESV, round, flat



Technical data

ESS-...-S...
ESV-...-S...

⌀ - Diameter
2 ... 200 mm

Function

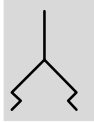

⌞ - Temperature range
-30 ... +200 °C

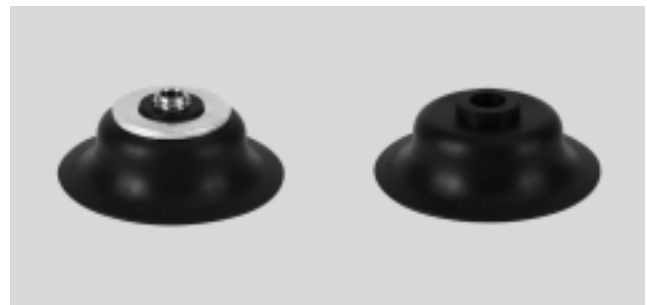

General technical data																	
Suction cup ⌀	[mm]	2	4	6	8	10	15	20	30	40	50	60	80	100	150	200	
Vacuum port		O.D. 3 mm ¹⁾		I.D. 4 mm ¹⁾		M4		M6				M10			M20x2		
Nominal size	[mm]	0.6	1.2	2				3				6		10			
Suction cup shape		Round, flat															
Type of mounting		Via vacuum port															
Connection position		On top															
Mounting position		Any															
Ejector pulse suitability	[bar]	≤ 4				-											

1) Is plugged onto or into the suction cup holder

Technical data						
Suction cup ⌀	Classification of suction cup holders → ESH	Holding force at nominal operating pressure -0.7 bar [N]	Suction cup volume [cm ³]	Min. workpiece radius [mm]	Weight	
					ESS [g]	ESV [g]
[mm]						
2	Size 1	0.1	0.002	10	0.1	-
4		0.46	0.008	10	0.1	-
6	Size 2	1.1	0.015	15	0.2	-
8		2.3	0.030	20	0.2	-
10	Size 3	3.9	0.050	30	1.5	-
15		8.5	0.208	35	1.9	-
20	Size 4	16.3	0.318	60	6.4	1.6
30		40.8	0.867	110	9	2.7
40		69.6	1.566	230	16.3	7.4
50		105.8	2.387	330	22	11.2
60	Size 5	166.1	3.953	350	49	22
80		309.7	19.312	400	133	33
100		503.6	29.779	460	222	59
150	Size 6	900	173.826	480	719	361
200		1,610	245.454	680	1,198	840

Suction cups with connection attachments ESS/suction cups ESV, round, flat

Technical data

Lateral force [N] at nominal operating pressure –0.7 bar					
Suction cup Ø [mm]	ESS-...-SF	ESS-...-SN	ESS-...-SNA	ESS-...-SS	ESS-...-SU
2	0.5	0.5	0.5	0.5	0.5
4	0.5	0.5	0.5	0.5	0.5
6	1.5	3.5	2	2.5	3
8	3.5	9.5	4	3.5	5
10	4.5	3.5	7.5	4	7
15	10.5	10.5	13.5	6.5	9
20	15.5	11.5	14.5	10.5	23
30	22	19.5	20	23.5	19
40	25	60	49	25	83
50	69.5	135	81.5	84	130
60	117.5	136	–	85	151
80	139.5	315	–	104	295
100	299	600	–	130	482.5
150	480	675	–	400	1,000
200	500	850	–	425	1,000

Operating and environmental conditions					
Type	ESS/ESV-...-SF	ESS/ESV-...-SN	ESS/ESV-...-SNA	ESS/ESV-...-SS	ESS/ESV-...-SU
Operating pressure [bar]	–0.95 ... 0				
Operating medium	Atmospheric air based on ISO 8573-1:2010 [7:--:-]				
Ambient temperature [°C]	–10 ... +200	–10 ... +70	–10 ... +70	–30 ... +180	–20 ... +60
Corrosion resistance class CRC ¹⁾	1				
Special features	–	–	Anti-static	–	–
Suitable for use in the food industry	–	–	–	As per manufacturer's declaration	–

1) CRC1: Corrosion resistance class to Festo standard 940 070
Components with light corrosion exposure. Protection for transport and storage. Components without significant decorative function or surface, e.g. installed out of sight internally or behind covers.

Materials					
Type	ESS/ESV-...-SF	ESS/ESV-...-SN	ESS/ESV-...-SNA	ESS/ESV-...-SS	ESS/ESV-...-SU
Shore hardness	60 ±5	50 ±5 (60 ±5) ¹⁾	50 ±5	50 ±5	60 ±5
Suction cup	FPM Colour: grey	NBR Colour: black	BR Colour: black/white dot	VMQ (silicone) Colour: transparent	PUR Colour: blue
Screw-in plug at suction cup Ø [mm]	2 ... 15	Nickel-plated brass			
		20, 30	Nickel-plated brass		
	Galvanised and chrome-plated steel				
	40, 50		Nickel-plated brass		
		Wrought aluminium alloy, nickel-plated			
		Galvanised and chrome-plated steel			
	60	Steel, nickel-plated	–	–	Steel, nickel-plated
		Wrought aluminium alloy, nickel-plated	–	–	Wrought aluminium alloy, nickel-plated
		Galvanised and chrome-plated steel	–	–	Galvanised and chrome-plated steel
	80, 100	Steel, nickel-plated	–	–	Steel, nickel-plated
		POM	–	–	POM
		Galvanised and chrome-plated steel	–	–	Galvanised and chrome-plated steel
150, 200	Steel, nickel-plated	–	–	Steel, nickel-plated	
	NBR	–	–	NBR	
	Galvanised and chrome-plated steel	–	–	Galvanised and chrome-plated steel	
Note on materials	RoHS-compliant				
	Free of copper and PTFE				
	–	Contains PWIS (paint-wetting impairment substances)			

1) Value in brackets applies to suction cup Ø 10 ... 100 mm

Suction cups with connection attachments ESS/suction cups ESV, round, flat

Technical data

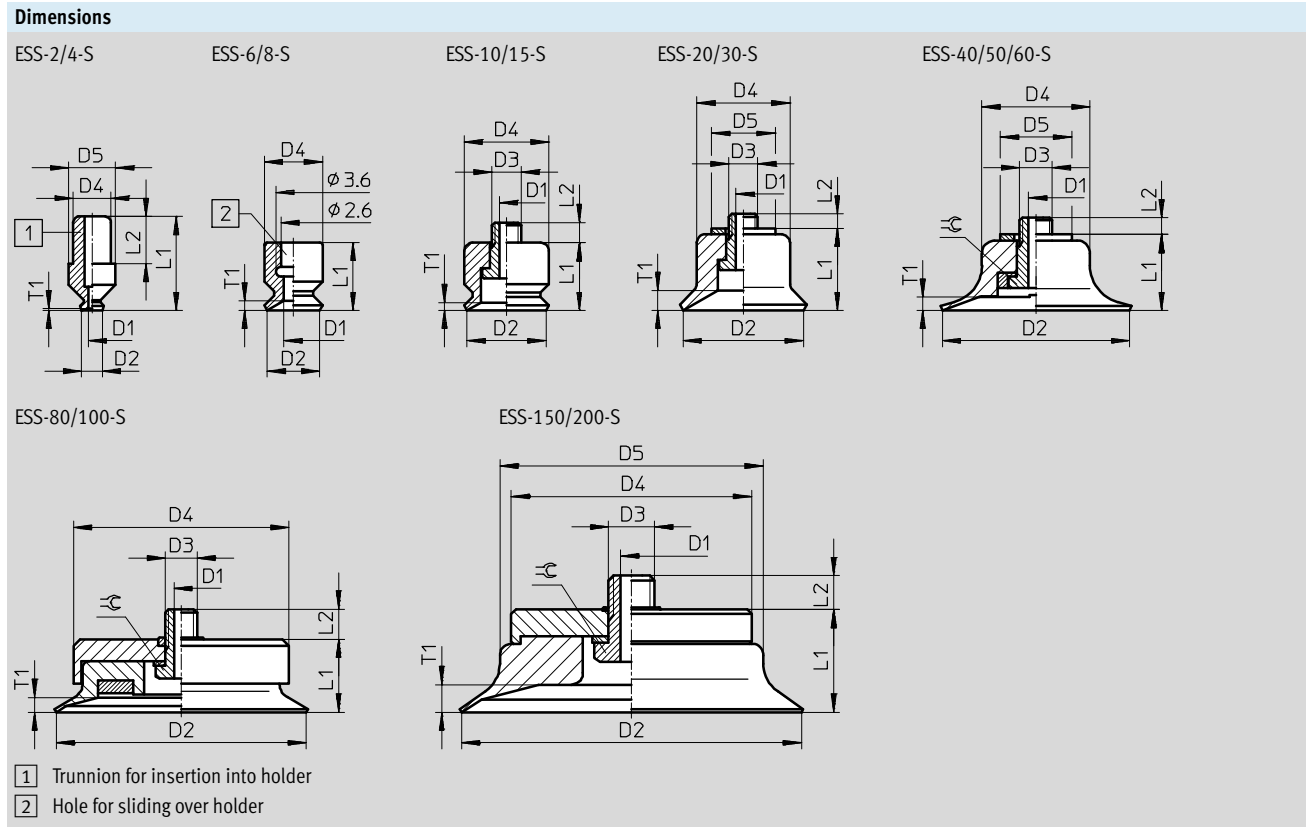

Suction cup type	For suction gripper	D1 NS	D2 Ø	D3	D4 Ø	D5 Ø	L1	L2	T1	⊕
ESS-2-S...	ESG-2-S...	Ø 0.6	2	-	3.2	4	8	4	0.2	-
ESS-4-S...	ESG-4-S...	Ø 1.2	4	-	3.2	4	8	4	0.6	-
ESS-6-S...	ESG-6-S...	Ø 2	6	-	6	-	7	-	1	-
ESS-8-S...	ESG-8-S...	Ø 2	8	-	6	-	5.5	-	1.1	-
ESS-10-S...	ESG-10-S...	⊕ 2	10	M4x0.7	10	-	8	3	1	-
ESS-15-S...	ESG-15-S...	⊕ 2	15	M4x0.7	11	-	9	3	2.4	-
ESS-20-S...	ESG-20-S...	⊕ 3	20	M6x1	15	18	11.6	2.4	1.8	-
ESS-30-S...	ESG-30-S...	⊕ 3	30	M6x1	17	18	12.6	3.4	2	-
ESS-40-S...	ESG-40-S...	⊕ 3	40	M6x1	25	22	15.6	3.2	1.9	-
ESS-50-S...	ESG-50-S...	⊕ 3	50	M6x1	30	22	16.6	3.2	1.6	-
ESS-60-S...	ESG-60-S...	Ø 6	60	M10x1.5	40	-	20.6	4.5	2.6	14
ESS-80-S...	ESG-80-S...	Ø 6	80	M10x1.5	68	-	23	9.4	4.7	14
ESS-100-S...	ESG-100-S...	Ø 6	100	M10x1.5	85	-	25	8.4	5.5	14
ESS-150-S...	ESG-150-S...	Ø 10	150	M20x2	105	115	45	13	12	27
ESS-200-S...	ESG-200-S...	Ø 10	200	M20x2	105	160	50	13	15	27

Suction cups with connection attachments ESS/suction cups ESV, round, flat



Technical data

Ordering data			
Suction cup Ø [mm]	ESS		ESV
	Part No.	Type	Part No. Type
Fluoro elastomer			
2	189267	ESS-2-SF	–
4	189272	ESS-4-SF	–
6	189277	ESS-6-SF	–
8	189282	ESS-8-SF	–
10	189287	ESS-10-SF	–
15	189292	ESS-15-SF	–
20	189297	ESS-20-SF	190982 ESV-20-SF
30	189302	ESS-30-SF	190987 ESV-30-SF
40	189307	ESS-40-SF	190992 ESV-40-SF
50	189312	ESS-50-SF	190997 ESV-50-SF
60	189317	ESS-60-SF	191002 ESV-60-SF
80	189321	ESS-80-SF	191006 ESV-80-SF
100	189325	ESS-100-SF	191010 ESV-100-SF
150	189329	ESS-150-SF	191014 ESV-150-SF
200	189333	ESS-200-SF	191018 ESV-200-SF
Nitrile rubber			
2	189264	ESS-2-SN	–
4	189269	ESS-4-SN	–
6	189274	ESS-6-SN	–
8	189279	ESS-8-SN	–
10	189284	ESS-10-SN	–
15	189289	ESS-15-SN	–
20	189294	ESS-20-SN	190979 ESV-20-SN
30	189299	ESS-30-SN	190984 ESV-30-SN
40	189304	ESS-40-SN	190989 ESV-40-SN
50	189309	ESS-50-SN	190994 ESV-50-SN
60	189314	ESS-60-SN	190999 ESV-60-SN
80	189318	ESS-80-SN	191003 ESV-80-SN
100	189322	ESS-100-SN	191007 ESV-100-SN
150	189326	ESS-150-SN	191011 ESV-150-SN
200	189330	ESS-200-SN	191015 ESV-200-SN
Butadiene rubber, anti-static			
2	189268	ESS-2-SNA	–
4	189273	ESS-4-SNA	–
6	189278	ESS-6-SNA	–
8	189283	ESS-8-SNA	–
10	189288	ESS-10-SNA	–
15	189293	ESS-15-SNA	–
20	189298	ESS-20-SNA	190983 ESV-20-SNA
30	189303	ESS-30-SNA	190988 ESV-30-SNA
40	189308	ESS-40-SNA	190993 ESV-40-SNA
50	189313	ESS-50-SNA	190998 ESV-50-SNA

Suction cups with connection attachments ESS/suction cups ESV, round, flat



Technical data

Ordering data			
Suction cup Ø [mm]	ESS		ESV
	Part No.	Type	Part No. Type
Silicone			
2	189266	ESS-2-SS	-
4	189271	ESS-4-SS	-
6	189276	ESS-6-SS	-
8	189281	ESS-8-SS	-
10	189286	ESS-10-SS	-
15	189291	ESS-15-SS	-
20	189296	ESS-20-SS	190981 ESV-20-SS
30	189301	ESS-30-SS	190986 ESV-30-SS
40	189306	ESS-40-SS	190991 ESV-40-SS
50	189311	ESS-50-SS	190996 ESV-50-SS
60	189316	ESS-60-SS	191001 ESV-60-SS
80	189320	ESS-80-SS	191005 ESV-80-SS
100	189324	ESS-100-SS	191009 ESV-100-SS
150	189328	ESS-150-SS	191013 ESV-150-SS
200	189332	ESS-200-SS	191017 ESV-200-SS
Polyurethane			
2	189265	ESS-2-SU	-
4	189270	ESS-4-SU	-
6	189275	ESS-6-SU	-
8	189280	ESS-8-SU	-
10	189285	ESS-10-SU	-
15	189290	ESS-15-SU	-
20	189295	ESS-20-SU	190980 ESV-20-SU
30	189300	ESS-30-SU	190985 ESV-30-SU
40	189305	ESS-40-SU	190990 ESV-40-SU
50	189310	ESS-50-SU	190995 ESV-50-SU
60	189315	ESS-60-SU	191000 ESV-60-SU
80	189319	ESS-80-SU	191004 ESV-80-SU
100	189323	ESS-100-SU	191008 ESV-100-SU
150	189327	ESS-150-SU	191012 ESV-150-SU
200	189331	ESS-200-SU	191016 ESV-200-SU

Suction cups with connection attachments ESS/suction cups ESV, extra deep



Technical data

ESS-...-E...
ESV-...-E...

⌀ - Diameter
15 ... 100 mm

Function

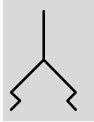

🌡 - Temperature range
-30 ... +200 °C



General technical data										
Suction cup Ø	[mm]	15	20	30	40	50	60	80	100	
Vacuum port		M4	M6				M10			
Nominal size	[mm]	2	3				6			
Suction cup shape		Round, extra deep								
Type of mounting		Via vacuum port								
Connection position		On top								
Mounting position		Any								

Technical data						
Suction cup Ø [mm]	Classification of suction cup holders ➔ ESH	Holding force at nominal operating pressure -0.7 bar [N]	Suction cup volume [cm ³]	Min. workpiece radius [mm]	Weight	
					ESS [g]	ESV [g]
15	Size 3	9.8	0.35	20	1.9	-
20	Size 4	17	0.84	30	6.4	1.6
30		37.2	2.12	50	9.2	2.9
40		67.6	4.04	80	16.9	8
50		103.6	7.90	100	23.4	12.6
60	Size 5	162.5	19.77	120	48	21
80		275	51.61	160	141	41
100		440.8	84.66	200	228	65

Lateral force [N] at nominal operating pressure -0.7 bar				
Suction cup Ø [mm]	ESS-...-EF	ESS-...-EN	ESS-...-ES	ESS-...-EU
15	14.5	9	10	15
20	15.5	14	13	16
30	18.5	24.5	21.5	41.5
40	22	53	28.5	46.5
50	60	115	42.5	62
60	62.5	130	63.5	134
80	148.5	216	107.5	136.5
100	254.5	351	150	352.5

Suction cups with connection attachments ESS/suction cups ESV, extra deep

Technical data

Operating and environmental conditions				
Type	ESS/ESV-...-EF	ESS/ESV-...-EN	ESS/ESV-...-ES	ESS/ESV-...-EU
Operating pressure [bar]	-0.95 ... 0			
Operating medium	Atmospheric air based on ISO 8573-1:2010 [7:-:-]			
Ambient temperature [°C]	-10 ... +200	-10 ... +70	-30 ... +180	-20 ... +60
Corrosion resistance class CRC ¹⁾	1			
Suitable for use in the food industry	-	-	As per manufacturer's declaration	-

1) CRC1: Corrosion resistance class to Festo standard 940 070
Components with light corrosion exposure. Protection for transport and storage. Components without significant decorative function or surface, e.g. installed out of sight internally or behind covers.

Materials				
Type	ESS/ESV-...-EF	ESS/ESV-...-EN	ESS/ESV-...-ES	ESS/ESV-...-EU
Shore hardness	60 ±5	60 ±5	50 ±5	60 ±5
Suction cup	FPM Colour: grey	NBR Colour: black	VMQ (silicone) Colour: transparent	PUR Colour: blue
Screw-in plug at suction cup Ø [mm]	15	Nickel-plated brass		
		Galvanised and chrome-plated steel		
	20, 30	Nickel-plated brass		
		Galvanised and chrome-plated steel		
		Nickel-plated brass		
	40, 50	Wrought aluminium alloy, nickel-plated		
		Galvanised and chrome-plated steel		
		Nickel-plated brass		
	60	Steel, nickel-plated		
		Wrought aluminium alloy, nickel-plated		
		Galvanised and chrome-plated steel		
	80, 100	Steel, nickel-plated		
POM				
Galvanised and chrome-plated steel				
Note on materials	RoHS-compliant			
	Free of copper and PTFE			
	-			
			Contains PWIS (paint-wetting impairment substances)	

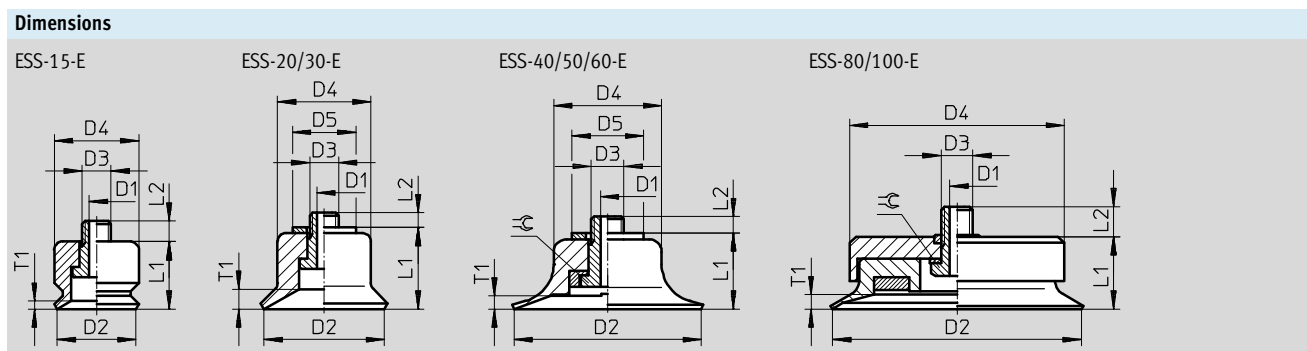

Suction cup type	For suction gripper	D1 NS	D2 Ø	D3	D4 Ø	D5 Ø	L1	L2	T1	⊕
ESS-15-E...	ESG-15-E...	⊕ 2	15	M4x0.7	11	-	10	3	2.9	-
ESS-20-E...	ESG-20-E...	⊕ 3	20	M6x1	15	18	12.6	2.4	3	-
ESS-30-E...	ESG-30-E...	⊕ 3	30	M6x1	17	18	15.6	3.4	4.5	-
ESS-40-E...	ESG-40-E...	⊕ 3	40	M6x1	25	22	19.1	3.2	4.5	-
ESS-50-E...	ESG-50-E...	⊕ 3	50	M6x1	30	22	21.1	3.9	6.5	-
ESS-60-E...	ESG-60-E...	Ø 6	60	M10x1.5	40	-	27.6	5.4	9.5	14
ESS-80-E...	ESG-80-E...	Ø 6	80	M10x1.5	68	-	33	9.4	8.6	14
ESS-100-E...	ESG-100-E...	Ø 6	100	M10x1.5	85	-	33	8.4	10.7	14

Suction cups with connection attachments ESS/suction cups ESV, extra deep



Technical data

Ordering data			
Suction cup Ø [mm]	ESS		ESV
	Part No.	Type	Part No. Type
Fluoro elastomer			
15	189337	ESS-15-EF	–
20	189341	ESS-20-EF	191026 ESV-20-EF
30	189345	ESS-30-EF	191030 ESV-30-EF
40	189349	ESS-40-EF	191034 ESV-40-EF
50	189353	ESS-50-EF	191038 ESV-50-EF
60	189357	ESS-60-EF	191042 ESV-60-EF
80	189361	ESS-80-EF	191046 ESV-80-EF
100	189365	ESS-100-EF	191050 ESV-100-EF
Nitrile rubber			
15	189334	ESS-15-EN	–
20	189338	ESS-20-EN	191023 ESV-20-EN
30	189342	ESS-30-EN	191027 ESV-30-EN
40	189346	ESS-40-EN	191031 ESV-40-EN
50	189350	ESS-50-EN	191035 ESV-50-EN
60	189354	ESS-60-EN	191039 ESV-60-EN
80	189358	ESS-80-EN	191043 ESV-80-EN
100	189362	ESS-100-EN	191047 ESV-100-EN
Silicone			
15	189336	ESS-15-ES	–
20	189340	ESS-20-ES	191025 ESV-20-ES
30	189344	ESS-30-ES	191029 ESV-30-ES
40	189348	ESS-40-ES	191033 ESV-40-ES
50	189352	ESS-50-ES	191037 ESV-50-ES
60	189356	ESS-60-ES	191041 ESV-60-ES
80	189360	ESS-80-ES	191045 ESV-80-ES
100	189364	ESS-100-ES	191049 ESV-100-ES
Polyurethane			
15	189335	ESS-15-EU	–
20	189339	ESS-20-EU	191024 ESV-20-EU
30	189343	ESS-30-EU	191028 ESV-30-EU
40	189347	ESS-40-EU	191032 ESV-40-EU
50	189351	ESS-50-EU	191036 ESV-50-EU
60	189355	ESS-60-EU	191040 ESV-60-EU
80	189359	ESS-80-EU	191044 ESV-80-EU
100	189363	ESS-100-EU	191048 ESV-100-EU

Suction cups with con. attachments ESS/suction cups ESV, bellows with 1.5 conv. **FESTO**

Technical data

ESS-...-B...
ESV-...-B...

⌀ - Diameter
10 ... 80 mm

Function

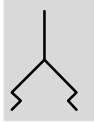

⌊ - Temperature range
-30 ... +180 °C



General technical data							
Suction cup ⌀	[mm]	10	20	30	40	50	80
Vacuum port		M4	M6				M10
Nominal size	[mm]	2	3				6
Suction cup shape		Round, bellows with 1.5 convolutions					
Type of mounting		Via vacuum port					
Connection position		On top					
Mounting position		Any					
Height compensation H1	[mm]	4	6	8	9.5	11	10

Height compensation H1

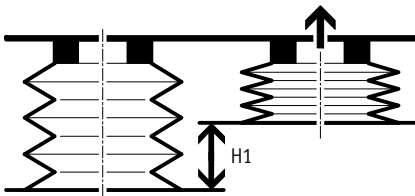

Technical data						
Suction cup ⌀ [mm]	Classification of suction cup holders → ESH	Holding force at nominal operating pressure -0.7 bar [N]	Suction cup volume [cm³]	Min. workpiece radius [mm]	Weight	
					ESS [g]	ESV [g]
10	Size 3	4.7	0.38	20	1.8	-
20	Size 4	12.9	1.60	40	6.7	1.9
30		26.2	4.07	80	9.9	3.6
40		52.3	8.87	90	18.7	9.8
50		72.6	14.23	150	24.7	13.9
80	Size 5	213.6	63.90	430	139	39

Lateral force [N] at nominal operating pressure -0.7 bar			
Suction cup ⌀ [mm]	ESS-...-BN	ESS-...-BS	ESS-...-BU
10	4.5	2.5	3
20	9.5	8	9.5
30	24.5	16	21.5
40	32.5	32.5	33
50	55.5	38	47
80	199.5	93	132.5

Suction cups with con. attachments ESS/suction cups ESV, bellows with 1.5 conv. FESTO

Technical data

Operating and environmental conditions			
Type	ESS/ESV-...-BN	ESS/ESV-...-BS	ESS/ESV-...-BU
Operating pressure [bar]	-0.95 ... 0		
Operating medium	Atmospheric air based on ISO 8573-1:2010 [7:-:-]		
Ambient temperature [°C]	-10 ... +70	-30 ... +180	-20 ... +60
Corrosion resistance class CRC ¹⁾	1		
Suitable for use in the food industry	-	As per manufacturer's declaration	-

1) CRC1: Corrosion resistance class to Festo standard 940 070
Components with light corrosion exposure. Protection for transport and storage. Components without significant decorative function or surface, e.g. installed out of sight internally or behind covers.

Materials			
Type	ESS/ESV-...-BN	ESS/ESV-...-BS	ESS/ESV-...-BU
Shore hardness	50 ±5	50 ±5	60 ±5
Suction cup	NBR Colour: black	VMQ (silicone) Colour: transparent	PUR Colour: blue
Screw-in plug at suction cup Ø [mm]	10	Nickel-plated brass	
	20, 30	Nickel-plated brass	
		Galvanised and chrome-plated steel	
	40, 50	Nickel-plated brass	
		Wrought aluminium alloy, nickel-plated	
		Galvanised and chrome-plated steel	
80	Steel, nickel-plated		
	POM		
	Galvanised and chrome-plated steel		
Note on materials	RoHS-compliant		
	Free of copper and PTFE		
	-	Contains PWIS (paint-wetting impairment substances)	

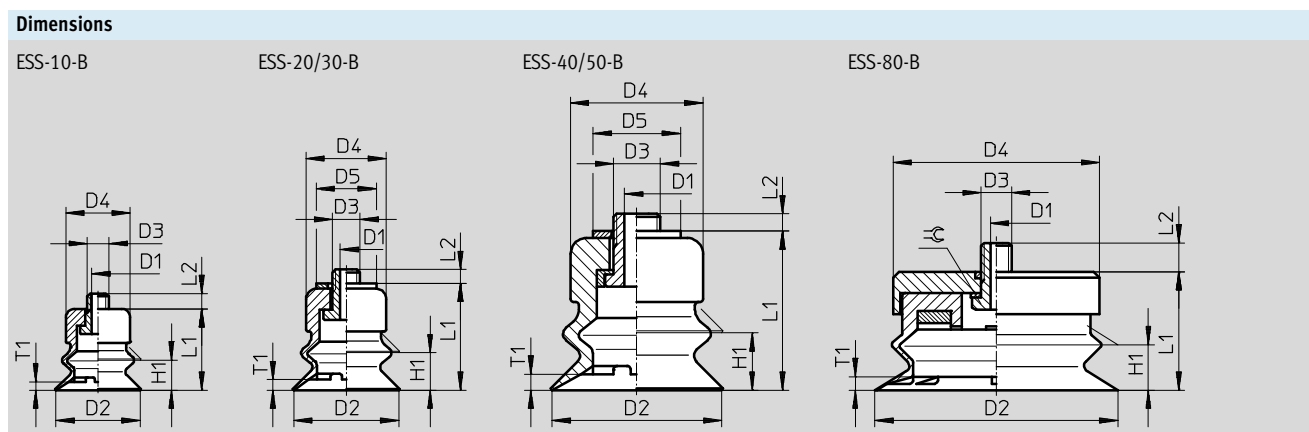

Suction cup type	For suction gripper	D1 NS	D2 Ø	D3	D4 Ø	D5 Ø	H1	L1	L2	T1	⊖
ESS-10-B...	ESG-10-B...	⊖ 2	10	M4x0.7	10	-	4	16	3	1	-
ESS-20-B...	ESG-20-B...	⊖ 3	20	M6x1	15	18	6	20.6	2.4	2	-
ESS-30-B...	ESG-30-B...	⊖ 3	30	M6x1	17	18	8	24.6	3.4	2.5	-
ESS-40-B...	ESG-40-B...	⊖ 3	40	M6x1	25	22	9.5	31.6	3.2	4	-
ESS-50-B...	ESG-50-B...	⊖ 3	50	M6x1	30	22	11	33.6	3.2	4	-
ESS-80-B...	ESG-80-B...	Ø 6	80	M10x1.5	68	-	10	39	9.4	2	14

Suction cups with con. attachments ESS/suction cups ESV, bellows with 1.5 conv. **FESTO**

Technical data

Ordering data			
Suction cup Ø [mm]	ESS		ESV
	Part No.	Type	Part No. Type
Nitrile rubber			
10	189374	ESS-10-BN	-
20	189378	ESS-20-BN	191054 ESV-20-BN
30	189382	ESS-30-BN	191057 ESV-30-BN
40	189386	ESS-40-BN	191060 ESV-40-BN
50	189390	ESS-50-BN	191063 ESV-50-BN
80	189394	ESS-80-BN	191066 ESV-80-BN
Silicone			
10	189376	ESS-10-BS	-
20	189380	ESS-20-BS	191056 ESV-20-BS
30	189384	ESS-30-BS	191059 ESV-30-BS
40	189388	ESS-40-BS	191062 ESV-40-BS
50	189392	ESS-50-BS	191065 ESV-50-BS
80	189396	ESS-80-BS	191068 ESV-80-BS
Polyurethane			
10	189375	ESS-10-BU	-
20	189379	ESS-20-BU	191055 ESV-20-BU
30	189383	ESS-30-BU	191058 ESV-30-BU
40	189387	ESS-40-BU	191061 ESV-40-BU
50	189391	ESS-50-BU	191064 ESV-50-BU
80	189395	ESS-80-BU	191067 ESV-80-BU

Suction cups with con. attachments ESS/suction cups ESV, bellows with 1.5 conv. **FESTO**

Technical data

ESS-...-BT
ESV-...-BT

⌀ - Diameter
40 ... 80 mm

Function

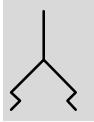

⌞ - Temperature range
-10 ... +80 °C



General technical data			
Suction cup ⌀	[mm]	40	50
Vacuum port		M6	-
		M10	
		G $\frac{1}{4}$ (female/male thread)	
Nominal size	[mm]	2.5	
Suction cup shape		Round, bellows with 1.5 convolutions	
Type of mounting		Via vacuum port	
Connection position		On top	
Mounting position		Any	
Height compensation H1	[mm]	9	10.5

Height compensation H1

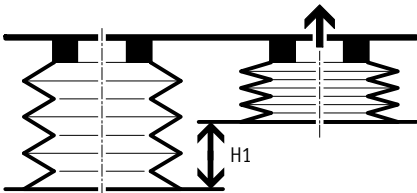

Technical data							
Suction cup ⌀	Vacuum port	Classification of suction cup holders → ESH	Holding force at nominal operating pressure -0.7 bar [N]	Suction cup volume [cm ³]	Min. workpiece radius [mm]	Weight	
						ESS [g]	ESV [g]
[mm]							
40	M6	Size 4	59	9.8	35	18	10.5
	M10	Size 5				19	
	G $\frac{1}{4}$ female thread	-				19	
	G $\frac{1}{4}$ male thread	-				20.5	
50	M6	Size 4	100	17.6	40	24	16.2
	M10	Size 5				25	
	G $\frac{1}{4}$ female thread	-				25	
	G $\frac{1}{4}$ male thread	-				26	
80	M10	Size 5	237	59.1	100	84.5	57.2
	G $\frac{1}{4}$ female thread	-				87.5	
	G $\frac{1}{4}$ male thread	-				85.5	

Lateral force [N] at nominal operating pressure -0.7 bar

Suction cup ⌀ [mm]	ESS-...-BT
40	22
50	39
80	102

Suction cups with con. attachments ESS/suction cups ESV, bellows with 1.5 conv. FESTO

Technical data

Operating and environmental conditions	
Operating pressure [bar]	-0.95 ... 0
Operating medium	Atmospheric air based on ISO 8573-1:2010 [7:-:-]
Ambient temperature [°C]	-10 ... +80
Corrosion resistance class CRC ¹⁾	2

1) CRC2: Corrosion resistance class to Festo standard 940 070
Components with medium corrosion exposure. Externally visible components with significant decorative function in direct contact with normal industrial atmosphere or media such as coolants and lubricants.

Materials	
Shore hardness	72 ±5
Suction cup	Vulkollan® Colour: reddish brown
Screw-in plug	Wrought aluminium alloy
Note on materials	RoHS-compliant Free of copper and PTFE

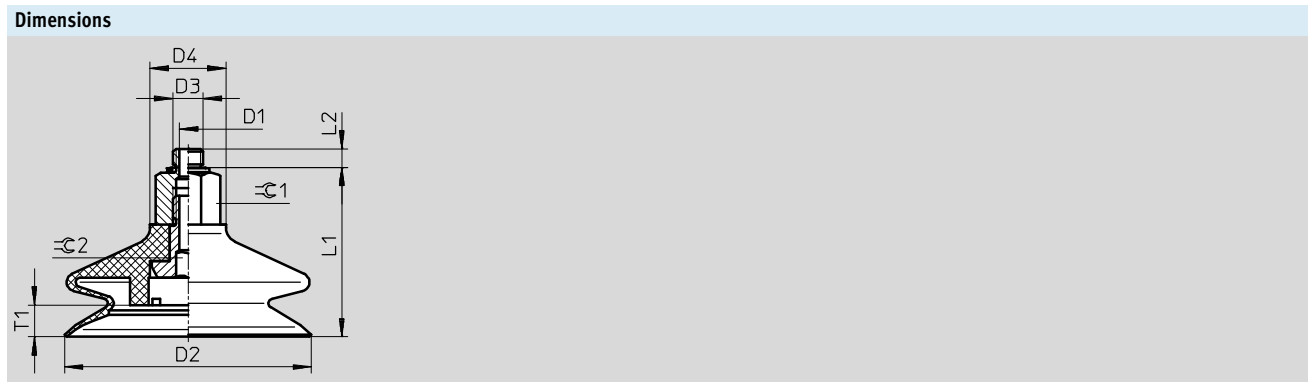

Type	D1 ∅ NS	D2 ∅	D3	D4 ∅	L1	L2	T1	R1 1	R2 2
ESS-40-BT	2.5	40	M6	20	36	3.45	9	15	4
ESS-40-BT-I			M10		36.3	6.2		17	
ESS-50-BT			G ¹ / ₄		48.3	-		17	
ESS-50-BT	2.5	50	M6	20	38.05	3.45	10	15	4
ESS-50-BT-I			M10		38.3	6.2		17	
ESS-80-BT			G ¹ / ₄		50.3	-		17	
ESS-80-BT	2.5	80	M10	20	53.3	6.2	10.5	22	8
ESS-80-BT-I			G ¹ / ₄		60.8	-		22	
ESS-80-BT-I			G ¹ / ₄		60.8	-		22	

Suction cups with con. attachments ESS/suction cups ESV, bellows with 1.5 conv. **FESTO**

Technical data

Ordering data					
Suction cup ∅ [mm]	Vacuum port	ESS		ESV	
		Part No.	Type	Part No.	Type
40	M6	525989	ESS-40-BT-M6	-	
	M10	525990	ESS-40-BT-M10	-	
	G¼ female thread	525991	ESS-40-BT-G¼-I	-	
	G¼ male thread	525992	ESS-40-BT-G¼	-	
	-	-	-	526006	ESV-40-BT
50	M6	525993	ESS-50-BT-M6	-	
	M10	525994	ESS-50-BT-M10	-	
	G¼ female thread	525995	ESS-50-BT-G¼-I	-	
	G¼ male thread	525996	ESS-50-BT-G¼	-	
	-	-	-	526007	ESV-50-BT
80	M10	525997	ESS-80-BT-M10	-	
	G¼ female thread	525998	ESS-80-BT-G¼-I	-	
	G¼ male thread	525999	ESS-80-BT-G¼	-	
	-	-	-	526008	ESV-80-BT

Suction cups with con. attachments ESS/suction cups ESV, bellows with 3.5 conv. **FESTO**

Technical data

ESS-...-C...
ESV-...-C...

⌀ - Diameter
10 ... 50 mm

Function

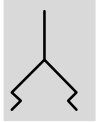

⌞ - Temperature range
-30 ... +180 °C



General technical data						
Suction cup ⌀	[mm]	10	20	30	40	50
Vacuum port		M4	M6			
Nominal size	[mm]	2	3			
Suction cup shape		Round, bellows with 3.5 convolutions				
Type of mounting		Via vacuum port				
Connection position		On top				
Mounting position		Any				
Height compensation H1	[mm]	3.3	7	10.5	12.8	17.5

Height compensation H1

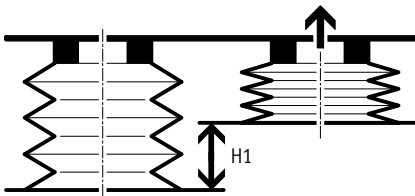

Technical data						
Suction cup ⌀ [mm]	Classification of suction cup holders → ESH	Holding force at nominal operating pressure -0.7 bar [N]	Suction cup volume [cm³]	Min. workpiece radius [mm]	Weight	
					ESS [g]	ESV [g]
10	Size 3	3.9	0.29	25	1.6	-
20	Size 4	8.2	2.75	50	6.9	2.1
30		20.8	9.47	80	12.2	5.8
40		42.4	19.72	100	21.9	13
50		63.4	38.92	180	32.1	21.3

Lateral force [N] at nominal operating pressure -0.7 bar		
Suction cup ⌀ [mm]	ESS-...-CN	ESS-...-CS
10	1.5	1
20	6.5	7
30	11.5	11
40	47.5	13
50	49	45.5

Suction cups with con. attachments ESS/suction cups ESV, bellows with 3.5 conv. **FESTO**

Technical data

Operating and environmental conditions		
Type	ESS/ESV-...-CN	ESS/ESV-...-CS
Operating pressure [bar]	-0.95 ... 0	
Operating medium	Atmospheric air based on ISO 8573-1:2010 [7:-:-]	
Ambient temperature [°C]	-10 ... +70	-30 ... +180
Corrosion resistance class CRC ¹⁾	1	
Suitable for use in the food industry	-	As per manufacturer's declaration

1) CRC1: Corrosion resistance class to Festo standard 940 070
Components with light corrosion exposure. Protection for transport and storage. Components without significant decorative function or surface, e.g. installed out of sight internally or behind covers.

Materials		
Type	ESS/ESV-...-CN	ESS/ESV-...-CS
Shore hardness	50 ±5	50 ±5
Suction cup	NBR Colour: black	VMQ (silicone) Colour: transparent
Screw-in plug at suction cup Ø [mm]	10	Nickel-plated brass
	20, 30	Nickel-plated brass
		Galvanised and chrome-plated steel
	40, 50	Nickel-plated brass
Wrought aluminium alloy, nickel-plated		
Galvanised and chrome-plated steel		
Note on materials	RoHS-compliant	
	Free of copper and PTFE	
	-	Contains PWIS (paint-wetting impairment substances)

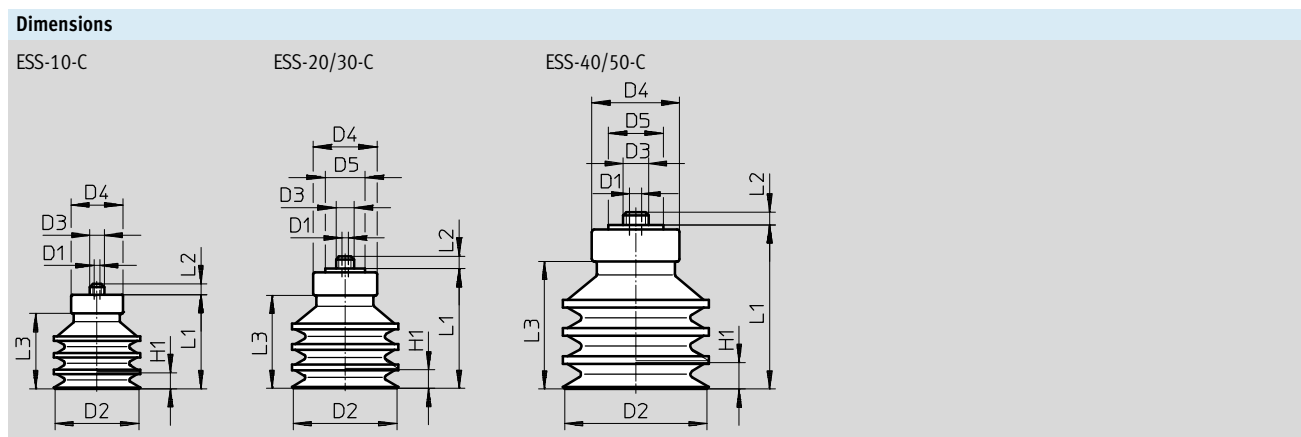

Suction cup type	For suction gripper	D1 ⌀ NS	D2 ⌀	D3	D4 ⌀	D5 ⌀	H1	L1	L2	L3
ESS-10-C...	ESG-10-C...	2	10	M4x0.7	10	-	3.3	12.7	3	8.7
ESS-20-C...	ESG-20-C...	3	20	M6x1	15	18	7	23	2.4	16.4
ESS-30-C...	ESG-30-C...	3	30	M6x1	18	18	10.5	34.3	3.4	26.2
ESS-40-C...	ESG-40-C...	3	40	M6x1	25	22	12.8	39.6	3.2	31
ESS-50-C...	ESG-50-C...	3	50	M6x1	30	22	17.5	48	3.2	39.4

Suction cups with con. attachments ESS/suction cups ESV, bellows with 3.5 conv. **FESTO**

Technical data

Ordering data				
Suction cup Ø [mm]	ESS		ESV	
	Part No.	Type	Part No.	Type
Nitrile rubber				
10	189398	ESS-10-CN	-	
20	189400	ESS-20-CN	191071	ESV-20-CN
30	189402	ESS-30-CN	191073	ESV-30-CN
40	189404	ESS-40-CN	191075	ESV-40-CN
50	189406	ESS-50-CN	191077	ESV-50-CN
Silicone				
10	189399	ESS-10-CS	-	
20	189401	ESS-20-CS	191072	ESV-20-CS
30	189403	ESS-30-CS	191074	ESV-30-CS
40	189405	ESS-40-CS	191076	ESV-40-CS
50	189407	ESS-50-CS	191078	ESV-50-CS

Suction cups with con. attachments ESS/suction cups ESV, round, deep

FESTO

Technical data

ESS-...-GT
ESV-...-GT

⌀ - Diameter
30 ... 100 mm

Function

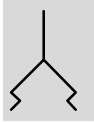

🌡 - Temperature range
-10 ... +80 °C



General technical data							
Suction cup ⌀	[mm]	30	40	50	60	80	100
Vacuum port		M6			-		
		M10					
		G $\frac{1}{8}$ (female/male thread)	-				
		-	G $\frac{1}{4}$ (female/male thread)				
Nominal size	[mm]	2.5			5.5		
Suction cup shape		Round, deep					
Type of mounting		Via vacuum port					
Connection position		On top					
Mounting position		Any					
Height compensation H1	[mm]	3.5	5.5	8	6	7.5	9

Technical data								
Suction cup ⌀	Vacuum port	Classification of suction cup hold- ers → ESH	Holding force at nominal operating pres- sure -0.7 bar [N]	Lateral force at nominal operating pres- sure -0.7 bar [N]	Suction cup volume [cm ³]	Min. workpiece radius [mm]	Weight	
							ESS	ESV
[mm]							[g]	[g]
30	M6	Size 4	36	13	2.4	26	12	4.2
	M10	Size 5					13	
	G $\frac{1}{8}$ -l female thread	-					14	
	G $\frac{1}{8}$ male thread	-					13	
40	M6	Size 4	64	20	5.4	35	14	5.7
	M10	Size 5					15	
	G $\frac{1}{4}$ -l female thread	-					14.5	
	G $\frac{1}{4}$ male thread	-					16	
50	M6	Size 4	97	30	11.2	40	17	9.2
	M10	Size 5					18	
	G $\frac{1}{4}$ -l female thread	-					18	
	G $\frac{1}{4}$ male thread	-					21	
60	M10	Size 5	134	37	11.3	75	20	10.7
	G $\frac{1}{4}$ -l female thread	-					19.5	
	G $\frac{1}{4}$ male thread	-					21	
80	M10	Size 5	245	99	28.6	100	28	30.9
	G $\frac{1}{4}$ -l female thread	-					61	
	G $\frac{1}{4}$ male thread	-					60	
100	M10	Size 5	375	183	53.9	135	86.5	58.9
	G $\frac{1}{4}$ -l female thread	-					89.5	
	G $\frac{1}{4}$ male thread	-					87.5	

Suction cups with con. attachments ESS/suction cups ESV, round, deep

Technical data

Operating and environmental conditions	
Operating pressure [bar]	-0.95 ... 0
Operating medium	Atmospheric air based on ISO 8573-1:2010 [7:-:-]
Ambient temperature [°C]	-10 ... +80
Corrosion resistance class CRC ¹⁾	2

1) CRC2: Corrosion resistance class to Festo standard 940 070
 Components with medium corrosion exposure. Externally visible components with significant decorative function in direct contact with normal industrial atmosphere or media such as coolants and lubricants.

Materials	
Shore hardness	72 ±5
Suction cup	Vulkollan® Colour: reddish brown
Screw-in plug	Wrought aluminium alloy
Note on materials	RoHS-compliant Free of copper and PTFE

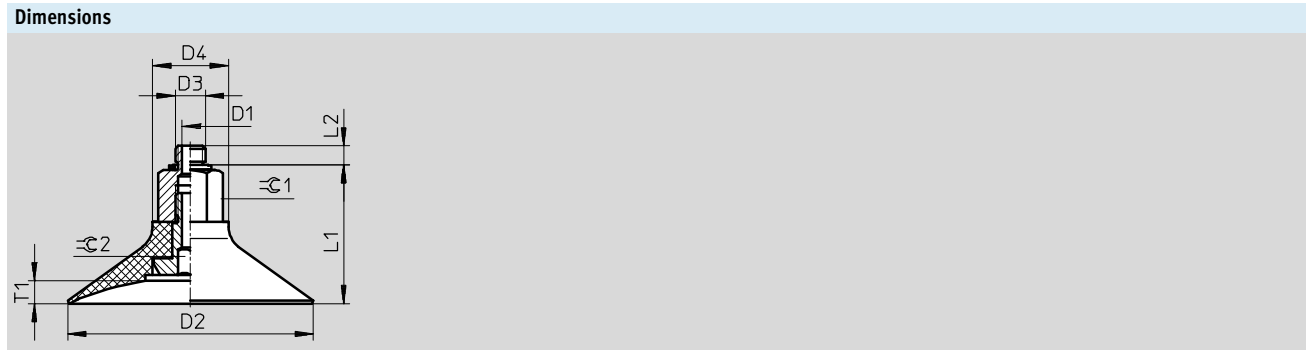

Type	D1 Ø NS	D2 Ø	D3	D4 Ø	L1	L2	T1	R1	R2
ESS-30-GT	2.5	30	M6	20	27.55	3.45	3.5	15	4
ESS-30-GT-I			M10		27.8	6.2		17	
			G1/8		36.8	4.7		15	
ESS-40-GT	2.5	40	M6	20	29.55	3.45	5.5	15	4
ESS-40-GT-I			M10		29.8	6.2		17	
			G1/4		41.8	-			
ESS-50-GT	2.5	50	M6	20	32.05	3.45	8	15	4
ESS-50-GT-I			M10		32.3	6.2		17	
			G1/4		44.3	-			
ESS-60-GT	2.5	60	M10	20	29.8	6.2	6	17	4
ESS-60-GT-I			G1/4		41.8	-			
			G1/4						
ESS-80-GT	5.5	80	M10	25	43.3	6.2	7.5	22	8
ESS-80-GT-I			G1/4		54.3	-			
			G1/4						
ESS-100-GT	5.5	100	M10	25	45.8	6.2	9	22	8
ESS-100-GT-I			G1/4		56.8	-			
			G1/4						

Suction cups with con. attachments ESS/suction cups ESV, round, deep

FESTO

Ordering data					
Suction cup ∅ [mm]	Vacuum port	ESS		ESV	
		Part No.	Type	Part No.	Type
30	M6	525968	ESS-30-GT-M6	-	
	M10	525969	ESS-30-GT-M10	-	
	G $\frac{1}{8}$ female thread	525970	ESS-30-GT-G $\frac{1}{8}$ -I	-	
	G $\frac{1}{8}$ male thread	525971	ESS-30-GT-G $\frac{1}{8}$	-	
	-	-	-	526000	ESV-30-GT
40	M6	525972	ESS-40-GT-M6	-	
	M10	525973	ESS-40-GT-M10	-	
	G $\frac{1}{4}$ female thread	525974	ESS-40-GT-G $\frac{1}{4}$ -I	-	
	G $\frac{1}{4}$ male thread	525975	ESS-40-GT-G $\frac{1}{4}$	-	
	-	-	-	526001	ESV-40-GT
50	M6	525976	ESS-50-GT-M6	-	
	M10	525977	ESS-50-GT-M10	-	
	G $\frac{1}{4}$ female thread	525978	ESS-50-GT-G $\frac{1}{4}$ -I	-	
	G $\frac{1}{4}$ male thread	525979	ESS-50-GT-G $\frac{1}{4}$	-	
	-	-	-	526002	ESV-50-GT
60	M10	525980	ESS-60-GT-M10	-	
	G $\frac{1}{4}$ female thread	525981	ESS-60-GT-G $\frac{1}{4}$ -I	-	
	G $\frac{1}{4}$ male thread	525982	ESS-60-GT-G $\frac{1}{4}$	-	
	-	-	-	526003	ESV-60-GT
80	M10	525983	ESS-80-GT-M10	-	
	G $\frac{1}{4}$ female thread	525984	ESS-80-GT-G $\frac{1}{4}$ -I	-	
	G $\frac{1}{4}$ male thread	525985	ESS-80-GT-G $\frac{1}{4}$	-	
	-	-	-	526004	ESV-80-GT
100	M10	525986	ESS-100-GT-M10	-	
	G $\frac{1}{4}$ female thread	525987	ESS-100-GT-G $\frac{1}{4}$ -I	-	
	G $\frac{1}{4}$ male thread	525988	ESS-100-GT-G $\frac{1}{4}$	-	
	-	-	-	526005	ESV-100-GT

Suction cups with connection attachments ESS, oval, flat

Technical data

ESS-...-0...

 Temperature range
 -10 ... +70 °C

Function

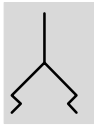

General technical data												
Suction cup size	[mm]	4x10	4x20	6x10	6x20	8x20	8x30	10x30	15x45	20x60	25x75	30x90
Vacuum port		M6								M10		
Nominal size	[mm]	2.5								6		
Suction cup shape		Oval, flat										
Type of mounting		Via vacuum port										
Connection position		On top										
Mounting position		Any										

Technical data				
Suction cup size	Classification of suction cup holders → ESH	Holding force at nominal operating pressure -0.7 bar	Suction cup volume	Weight
[mm]		[N]	[cm ³]	[g]
4x10	Size 4	2	0.064	2
4x20		3.4	0.112	2.5
6x10		2.9	0.106	2
6x20		5.9	0.196	2.5
8x20		8	0.256	2.5
8x30		10.9	0.376	3
10x30		15.2	0.35	2.9
15x45	Size 5	32	1.57	23.8
20x60		62.8	3.69	30.8
25x75		92.5	6.70	46.8
30x90		134.4	10.17	55.3

Lateral force [N] at nominal operating pressure -0.7 bar		
Suction cup size	Horizontal	Vertical
[mm]		
4x10	3.5	5
4x20	4.5	11
6x10	7.5	12
6x20	9	12.5
8x20	11	13
8x30	17	13.5
10x30	23	16
15x45	43	35
20x60	116	63
25x75	125.5	115
30x90	201	134.5

Suction cups with connection attachments ESS, oval, flat

Technical data

Operating and environmental conditions	
Operating pressure [bar]	-0.95 ... 0
Operating medium	Atmospheric air based on ISO 8573-1:2010 [7:-:-]
Ambient temperature [°C]	-10 ... +70
Corrosion resistance class CRC ¹⁾	1

1) CRC1: Corrosion resistance class to Festo standard 940 070
Components with light corrosion exposure. Protection for transport and storage. Components without significant decorative function or surface, e.g. installed out of sight internally or behind covers.

Materials	
Shore hardness	50 ±5
Suction cup	NBR Colour: black
Note on materials	RoHS-compliant Free of copper and PTFE

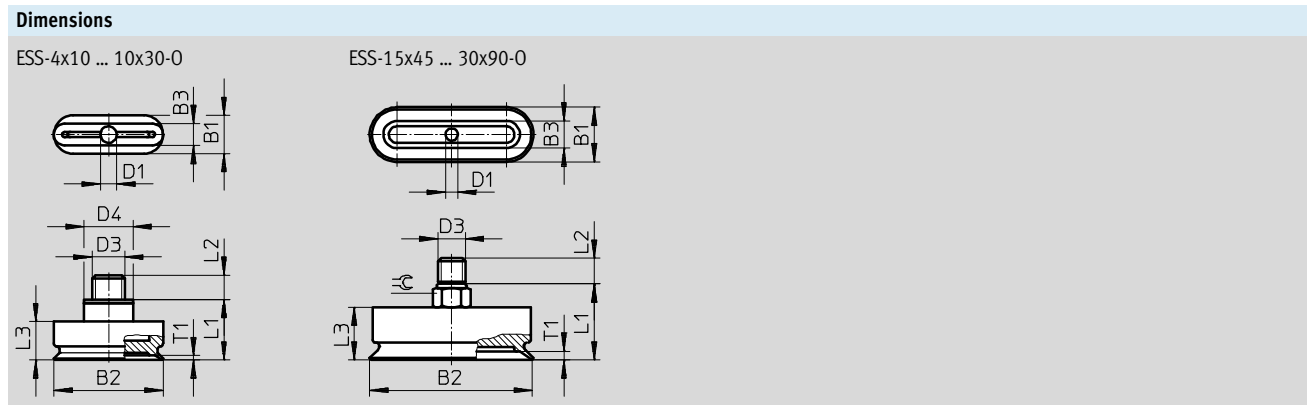

Type	For suction gripper	B1	B2	B3	D1 ∅ NS	D3	D4 ∅	L1	L2	L3	T1	⊕
ESS-4x10-0...	ESG-4x10-0...	7	10	4	2.5	M6x1	9	11.1	4.4	7	0.8	-
ESS-4x20-0...	ESG-4x20-0...	7	20	4	2.5	M6x1	9	11.1	4.4	7	0.8	-
ESS-6x10-0...	ESG-6x10-0...	7	10	6	2.5	M6x1	9	11.1	4.4	7	1	-
ESS-6x20-0...	ESG-6x20-0...	7	20	6	2.5	M6x1	9	11.1	4.4	7	1	-
ESS-8x20-0...	ESG-8x20-0...	7	20	8	2.5	M6x1	9	11.1	4.4	7	1	-
ESS-8x30-0...	ESG-8x30-0...	7	30	8	2.5	M6x1	9	11.1	4.4	7	1	-
ESS-10x30-0...	ESG-10x30-0...	10	30	7	2.5	M6x1	9	11.1	4.4	7	1.1	-
ESS-15x45-0...	ESG-15x45-0...	15	45	15	6	M10x1.5	-	25.5	8.5	18.5	2.5	12
ESS-20x60-0...	ESG-20x60-0...	20	60	20	6	M10x1.5	-	26.3	8.5	19.3	3.2	12
ESS-25x75-0...	ESG-25x75-0...	25	75	25	6	M10x1.5	-	28	8.5	21	3.7	12
ESS-30x90-0...	ESG-30x90-0...	30	90	30	6	M10x1.5	-	28.5	8.5	21.5	3.7	12

Suction cups with connection attachments ESS, oval, flat

Technical data

Ordering data		
Suction cup size [mm]	ESS	
	Part No.	Type
Nitrile rubber		
4x10	189408	ESS-4X10-ON
4x20	189409	ESS-4X20-ON
6x10	189410	ESS-6X10-ON
6x20	189411	ESS-6X20-ON
8x20	189412	ESS-8X20-ON
8x30	189413	ESS-8X30-ON
10x30	189414	ESS-10X30-ON
15x45	189415	ESS-15X45-ON
20x60	189416	ESS-20X60-ON
25x75	189417	ESS-25X75-ON
30x90	189418	ESS-30X90-ON

Suction cups with connection attachments ESS/suction cups ESV

Accessories

Suction cup insert OASI

For suction cups with connection attachments/suction cups, bellows with 3.5 convolutions

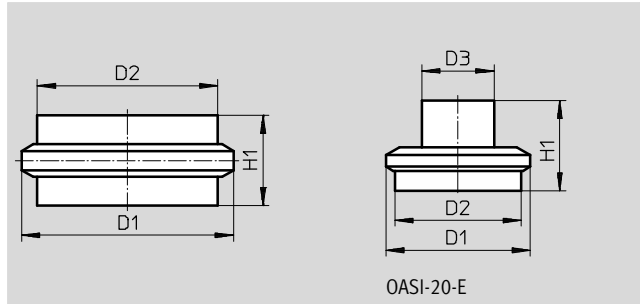

The suction cup insert is compatible with the ESG suction gripper range. It is suitable for bellows suction cups with 3.5 convolutions and is simply snapped into the bellows.

The support offered by the suction cup insert enables delicate and fragile workpieces to be transported.

Areas of application:

- Semiconductor industry (wafers, solar cells)
- Electronics industry (printed circuit boards, plastic film)
- Paper industry
- PE film

 Note
The suction cup insert's location in the evacuation path means that it filters the air that has been drawn in and thus becomes contaminated. Like other filters, it must be replaced if it becomes contaminated.

Technical data						
Type	OASI-10	OASI-20	OASI-20-E	OASI-30	OASI-40	OASI-50
Operating pressure [bar]	-0.95 ... 0					
Operating medium	Atmospheric air based on ISO 8573-1:2010 [7:-:-]					
Ambient temperature [°C]	5 ... 50					
Ejector pulse suitability [bar]	0	≤0.5		≤2	≤5	
Type of mounting	Push-in					
Mounting position	Any		Inner trunnion	Any	Inner recess	
Suitable for use in the food industry	As per manufacturer's declaration					
Material						
Suction cup insert	PE					
Note on materials	RoHS-compliant					

Dimensions and ordering data						
D1	D2	D3	H1	Weight [g]	Part No.	Type
7	6	-	3	0.1	1048645	OASI-10
16	14	-	6.5	0.6	1048877	OASI-20
16	14	8	10	0.6	1072015	OASI-20-E ¹⁾
23.5	20	-	10	2.1	1048880	OASI-30
33	27	-	12	2.9	1048881	OASI-40
40	32	-	15	5.9	1048884	OASI-50

1) Additional feature E: suction cup insert with stop