

Verstekzagen Balken

Allereerst dient het L-totaal te worden opgegeven. Het is daarnaast voldoende om α en (in voorkomende gevallen) β te specificeren. Geef tenslotte naast de gewenste maten/hoeken ook de letter (A-B-C etc.) in het zwarte vakje op.

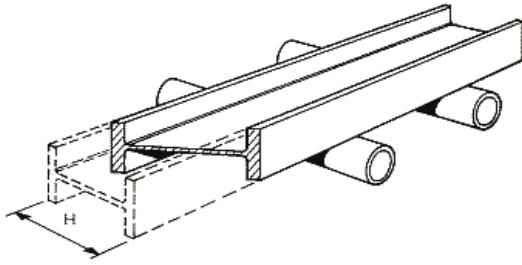

A

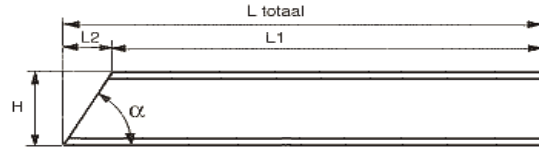

B

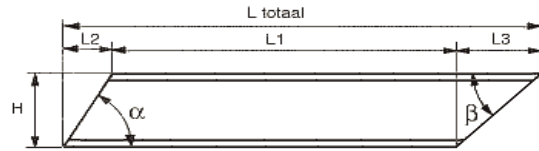

C

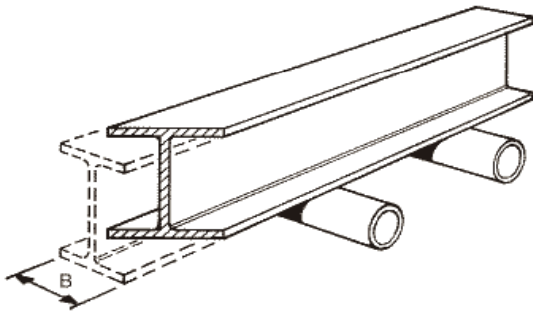
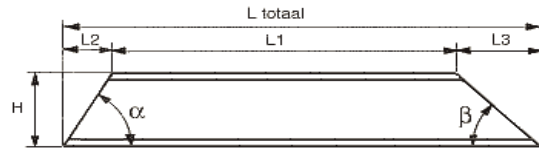

D

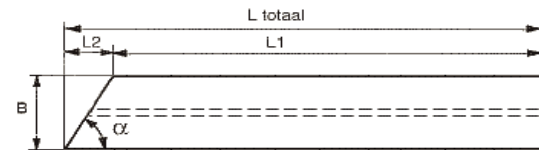

E

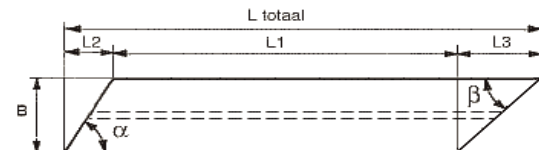

F

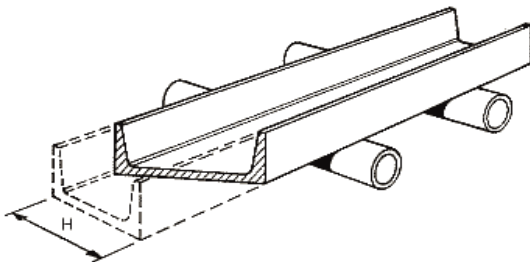
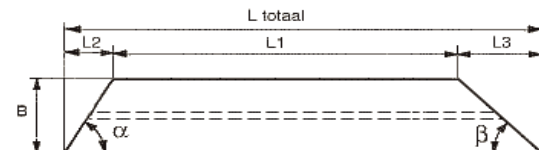

J

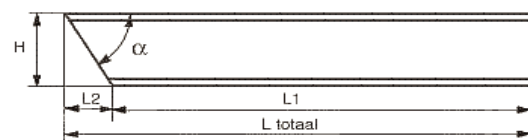

K

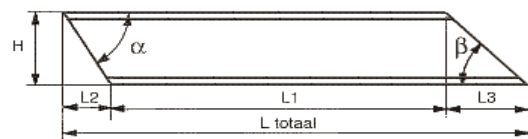

L

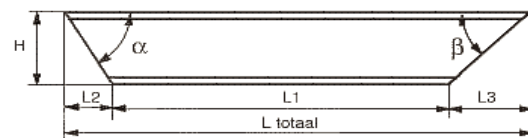

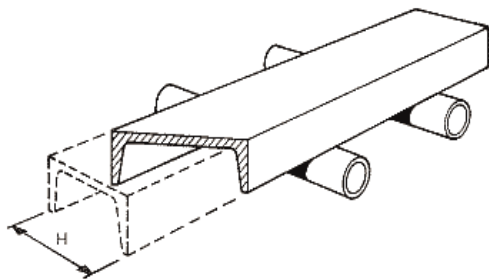

M

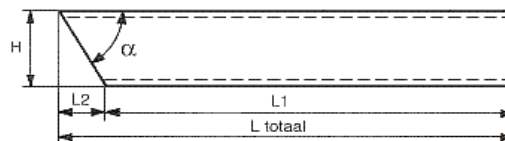

N

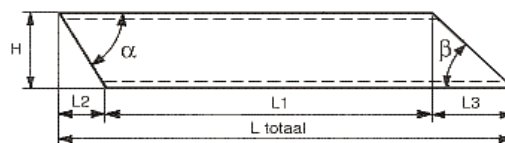

O

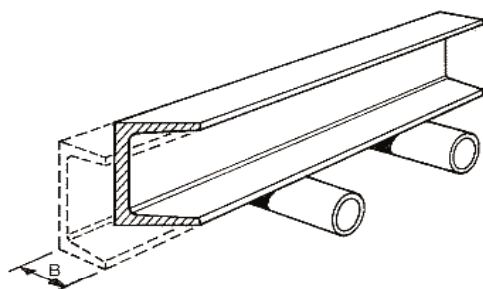
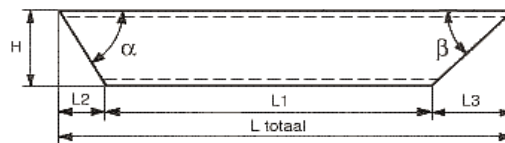

P

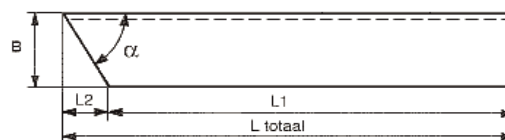

Q

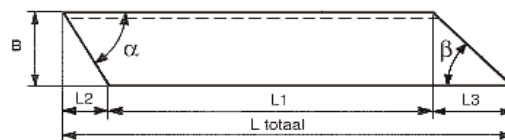

R

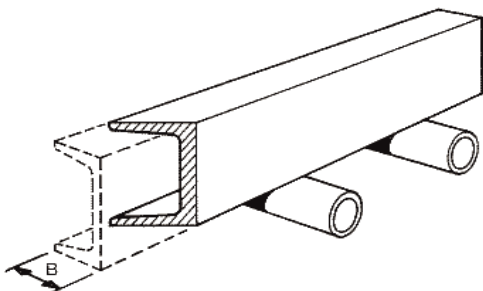
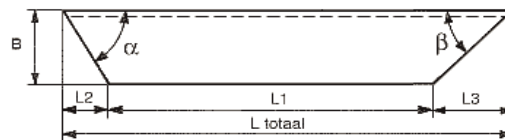

S

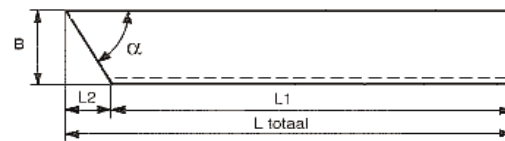

T

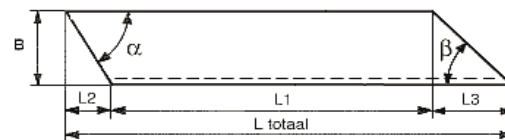

U

